

Toroidal Schnyder woods

Benjamin Lévêque

CNRS, LIRMM, Montpellier, France

Schnyder woods (planar triangulations)

Schnyder (1989)

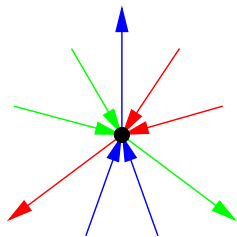

For every inner vertex

Schnyder woods (planar triangulations)

Schnyder (1989)

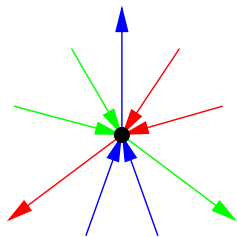

For every inner vertex

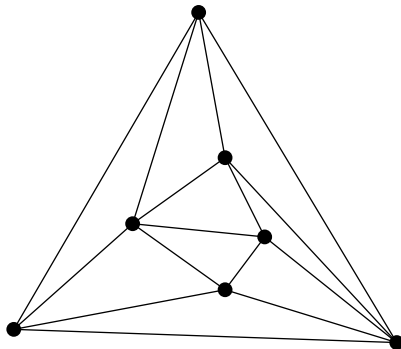

Schnyder woods (planar triangulations)

Schnyder (1989)

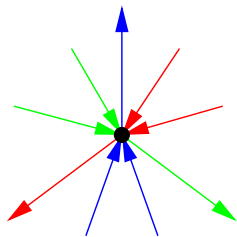

For every inner vertex

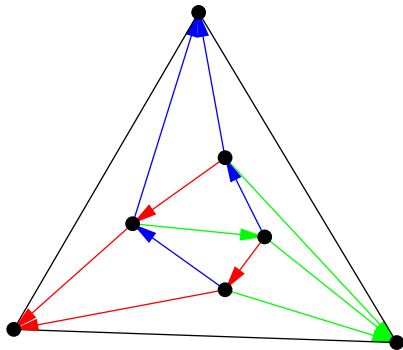

Schnyder woods (planar triangulations)

Schnyder (1989)

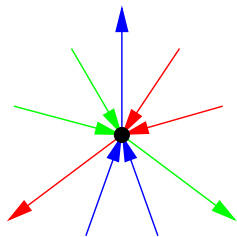

For every inner vertex

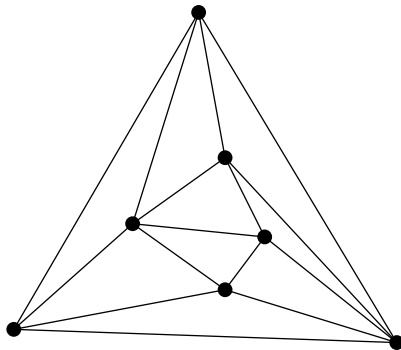

Schnyder woods (planar triangulations)

Schnyder (1989)

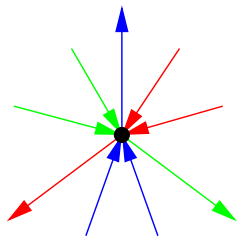

For every inner vertex

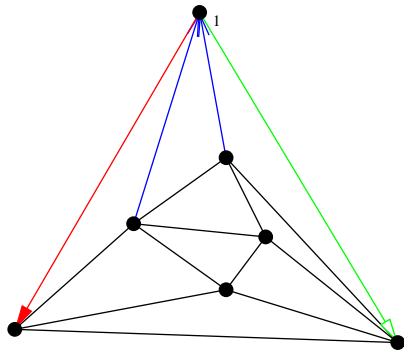

Schnyder woods (planar triangulations)

Schnyder (1989)

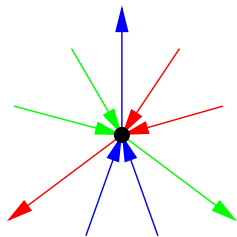

For every inner vertex

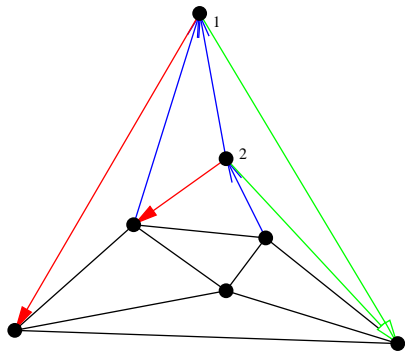

Schnyder woods (planar triangulations)

Schnyder (1989)

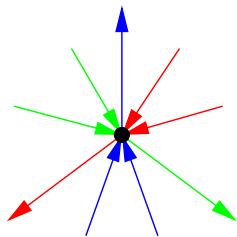

For every inner vertex

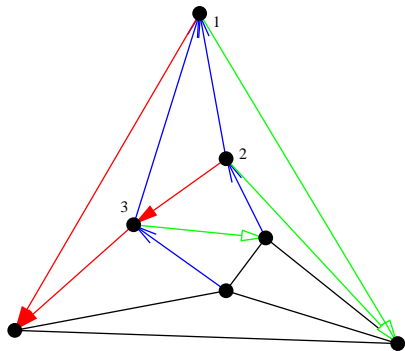

Schnyder woods (planar triangulations)

Schnyder (1989)

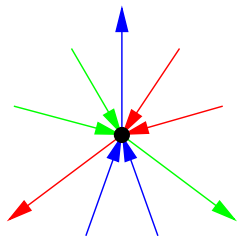

For every inner vertex

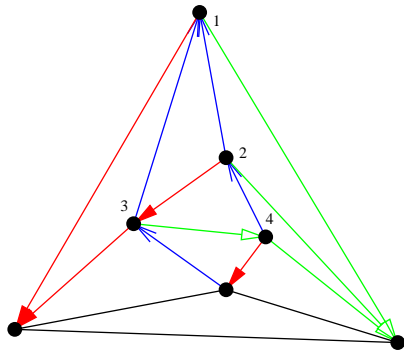

Schnyder woods (planar triangulations)

Schnyder (1989)

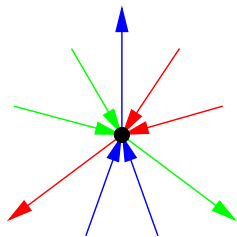

For every inner vertex

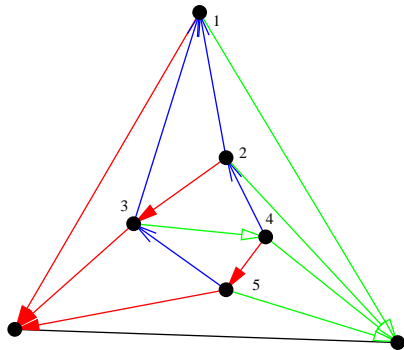

Schnyder woods (planar triangulations)

Schnyder (1989)

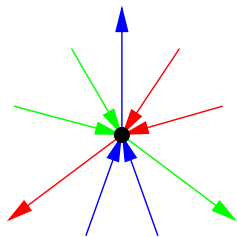

For every inner vertex

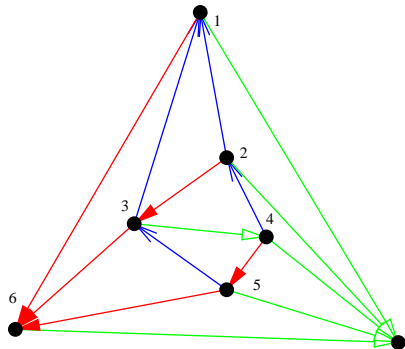

Schnyder woods (planar triangulations)

Schnyder (1989)

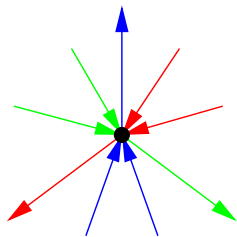

For every inner vertex

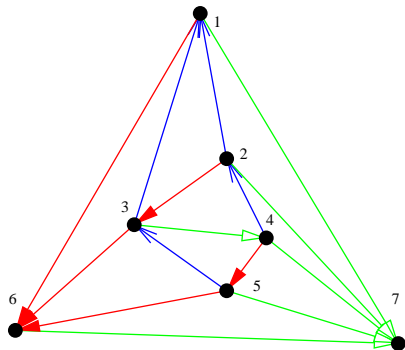

Schnyder woods (planar triangulations)

Schnyder (1989)

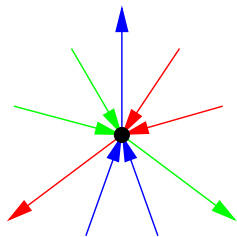

For every inner vertex

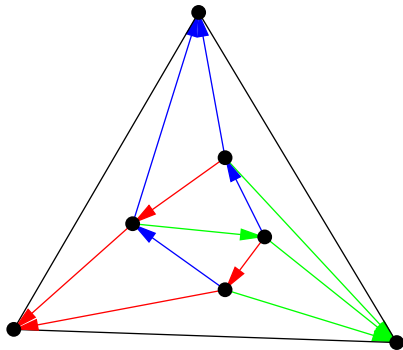

Schnyder woods (planar triangulations)

Schnyder (1989)

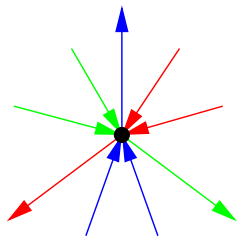

For every inner vertex

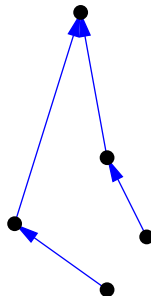

Schnyder woods (planar triangulations)

Schnyder (1989)

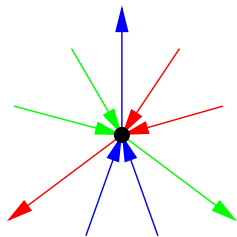

For every inner vertex

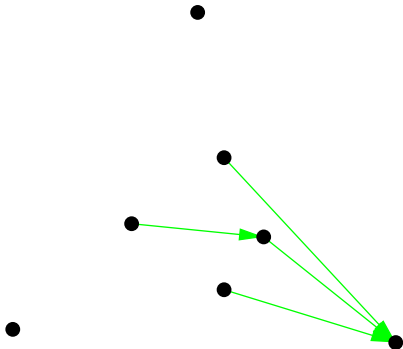

Schnyder woods (planar triangulations)

Schnyder (1989)

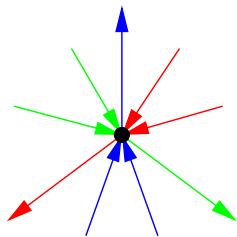

For every inner vertex

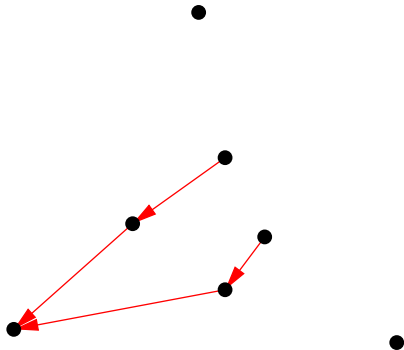

Schnyder woods (planar triangulations)

Schnyder (1989)

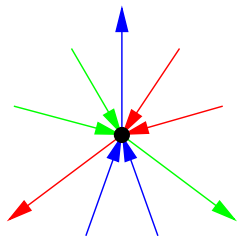

For every inner vertex

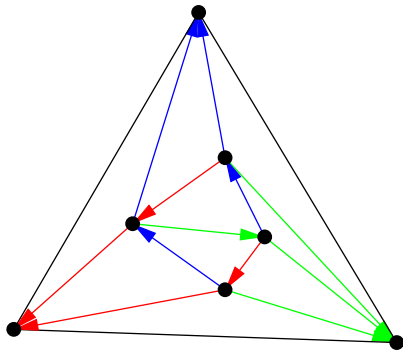

Schnyder woods (planar triangulations)

Schnyder (1989)

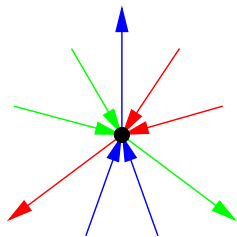

For every inner vertex

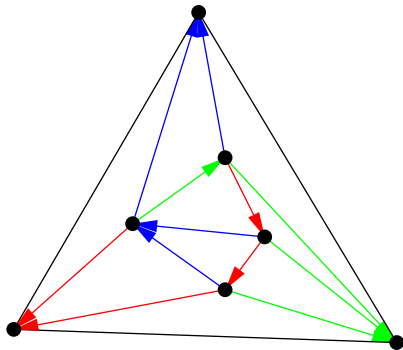

Schnyder woods (planar triangulations)

Schnyder (1989)

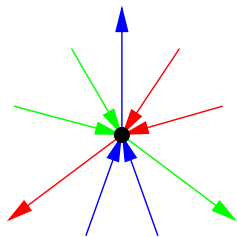

For every inner vertex

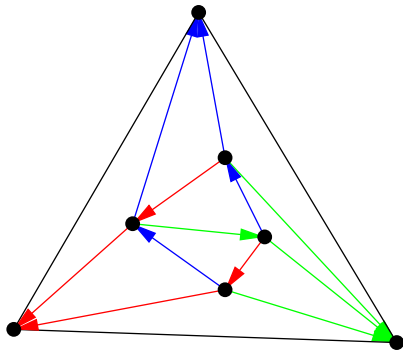

Schnyder woods (planar triangulations)

Schnyder (1989)

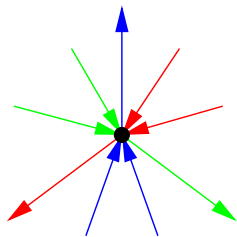

For every inner vertex

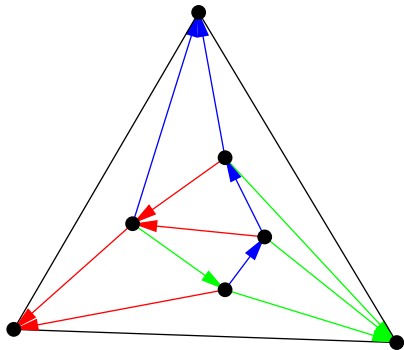

Schnyder woods (planar triangulations)

Schnyder (1989)

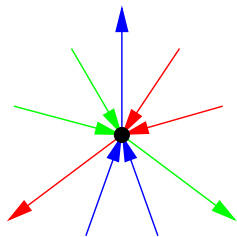

For every inner vertex

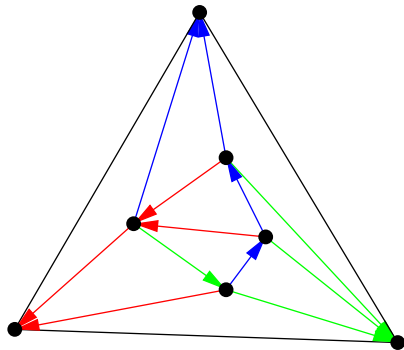

Planar graph \iff Incident poset has DM-dimension ≤ 3

Optimal encoding

Poulalhon and Schaeffer (2003)

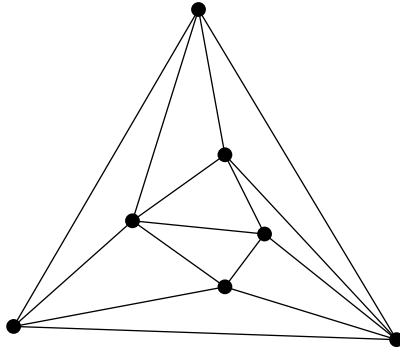

Optimal encoding

Poulalhon and Schaeffer (2003)

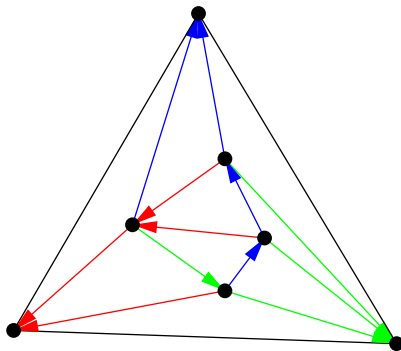

Optimal encoding

Poulalhon and Schaeffer (2003)

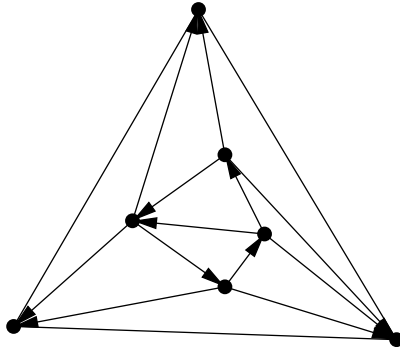

Optimal encoding

Poulalhon and Schaeffer (2003)

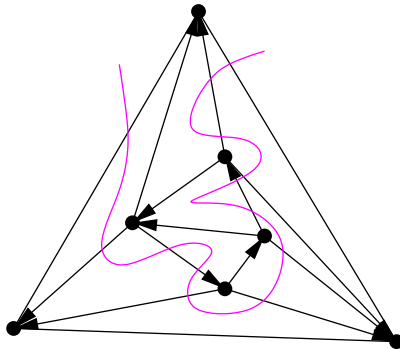

Optimal encoding

Poulalhon and Schaeffer (2003)

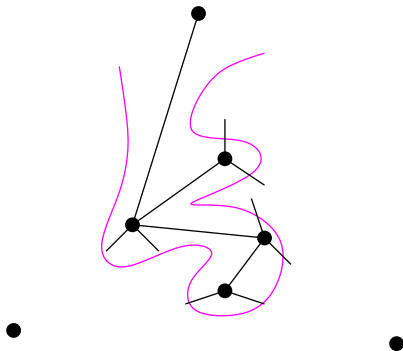

Optimal encoding

Poulalhon and Schaeffer (2003)

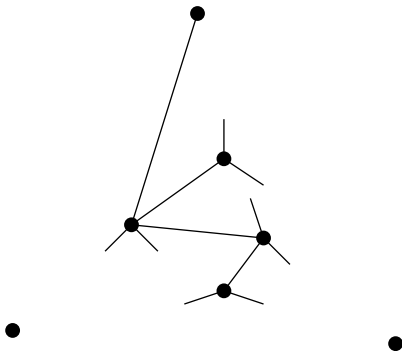

Optimal encoding

Poulalhon and Schaeffer (2003)

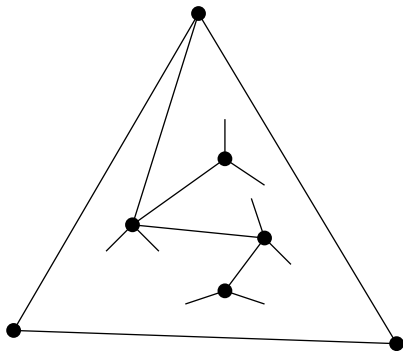

Optimal encoding

Poulalhon and Schaeffer (2003)

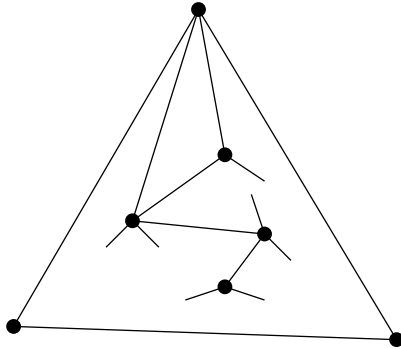

Optimal encoding

Poulalhon and Schaeffer (2003)

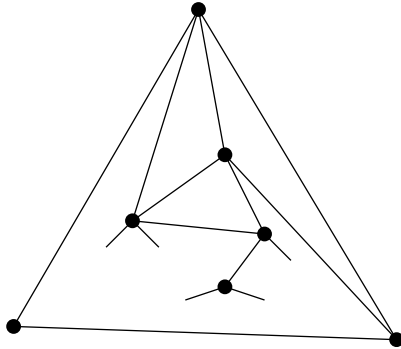

Optimal encoding

Poulalhon and Schaeffer (2003)

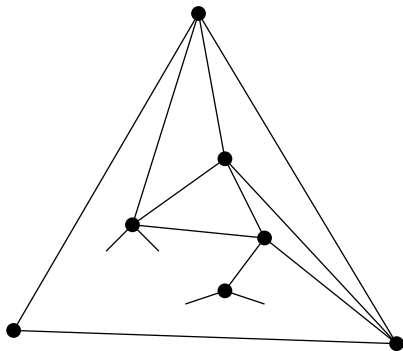

Optimal encoding

Poulalhon and Schaeffer (2003)

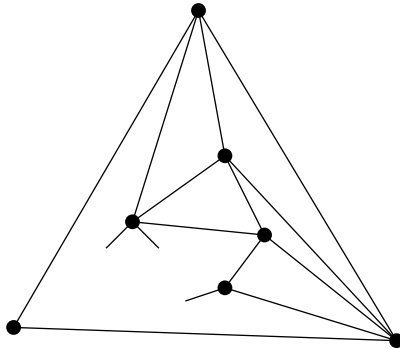

Optimal encoding

Poulalhon and Schaeffer (2003)

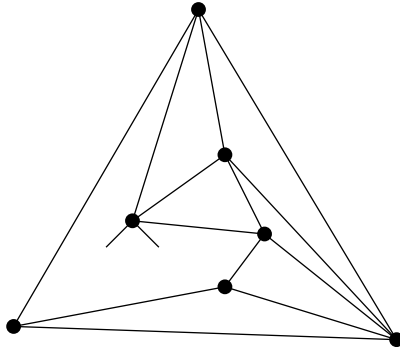

Optimal encoding

Poulalhon and Schaeffer (2003)

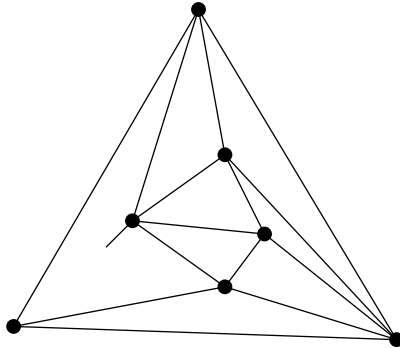

Optimal encoding

Poulalhon and Schaeffer (2003)

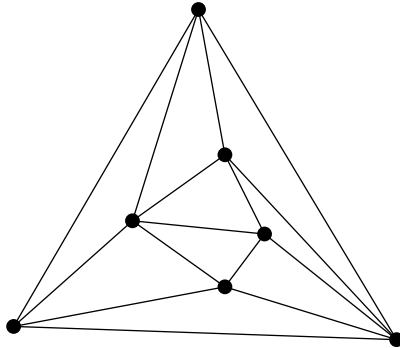

Optimal encoding

Poulalhon and Schaeffer (2003)

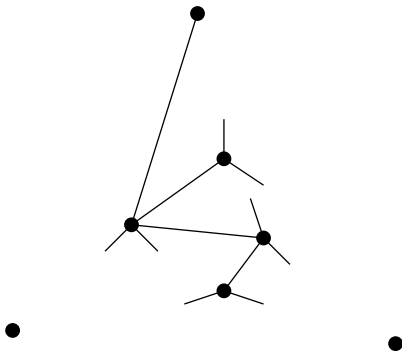

Optimal encoding

Poulalhon and Schaeffer (2003)

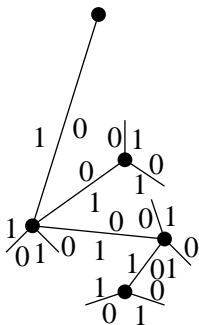

110101110100101001101000 \rightsquigarrow 6n bits

Optimal encoding

Poulalhon and Schaeffer (2003)

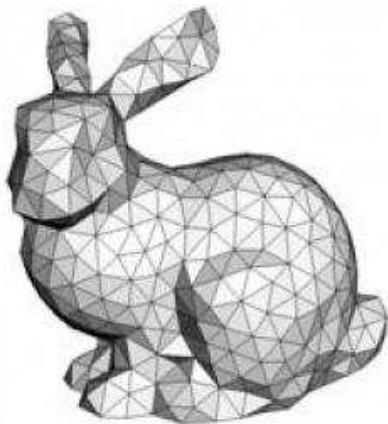

1001100000010000 \rightsquigarrow 4n bits (n bits 1) \rightsquigarrow 3,25n bits

...1w10w10w0...

OPTIMAL !

Generalization to 3-connected planar map

Felsner (2001), Miller (2002)

Generalization to 3-connected planar map

Felsner (2001), Miller (2002)

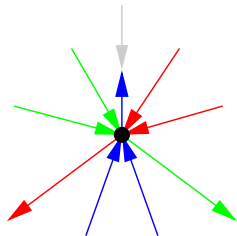

Generalization to 3-connected planar map

Felsner (2001), Miller (2002)

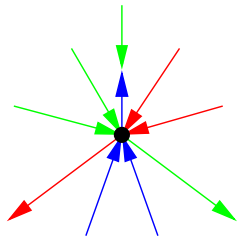

Generalization to 3-connected planar map

Felsner (2001), Miller (2002)

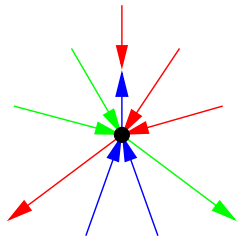

Generalization to 3-connected planar map

Felsner (2001), Miller (2002)

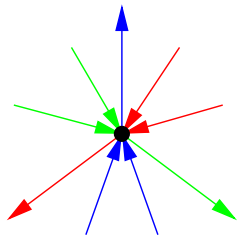

For every vertex

Generalization to 3-connected planar map

Felsner (2001), Miller (2002)

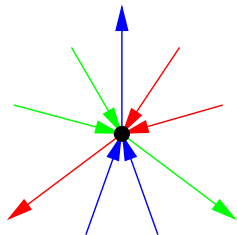

For every vertex

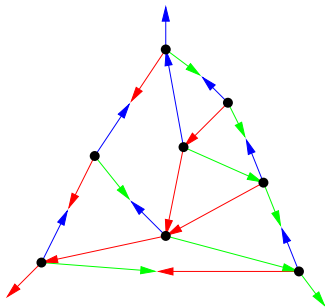

Generalization to 3-connected planar map

Felsner (2001), Miller (2002)

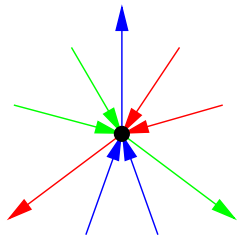

For every vertex

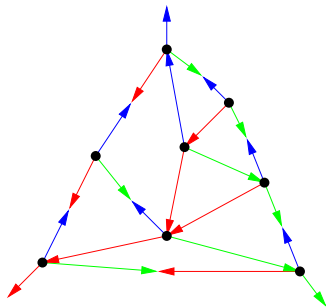

AND

No monochromatic cycles

Generalization to (internally) 3-connected planar map

Felsner (2001), Miller (2002)

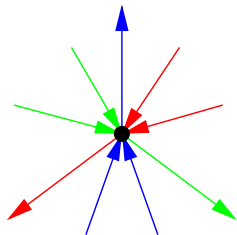

For every vertex

AND

No monochromatic cycles

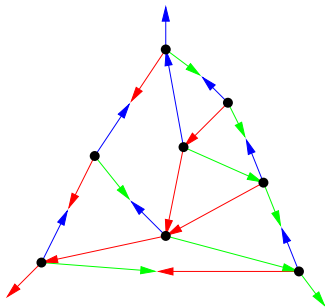

Generalization to (internally) 3-connected planar map

Felsner (2001), Miller (2002)

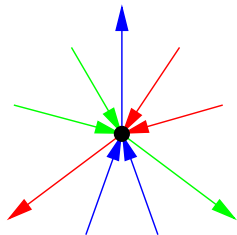

For every vertex

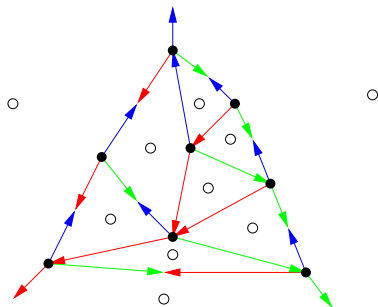

AND

No monochromatic cycles

Generalization to (internally) 3-connected planar map

Felsner (2001), Miller (2002)

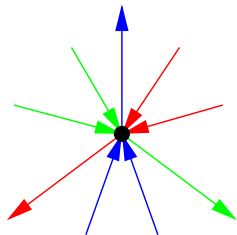

For every vertex

AND

No monochromatic cycles

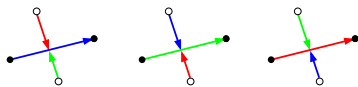
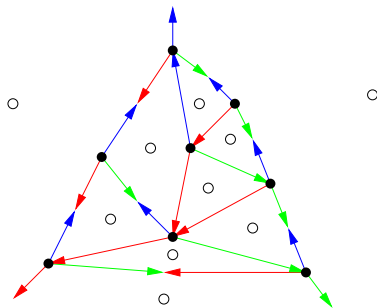

Dual rules

Generalization to (internally) 3-connected planar map

Felsner (2001), Miller (2002)

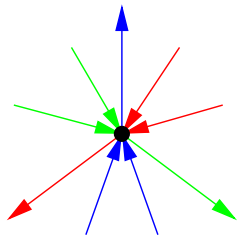

For every vertex

AND

No monochromatic cycles

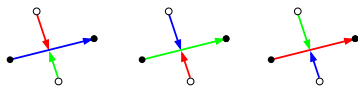
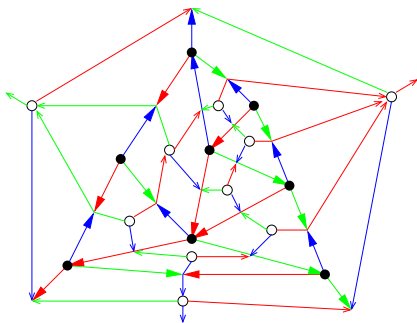

Dual rules

Generalization to (internally) 3-connected planar map

Felsner (2001), Miller (2002)

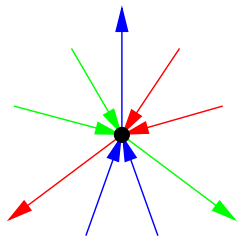

For every vertex

AND

No monochromatic cycles

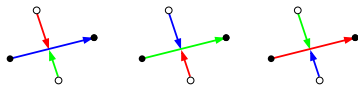
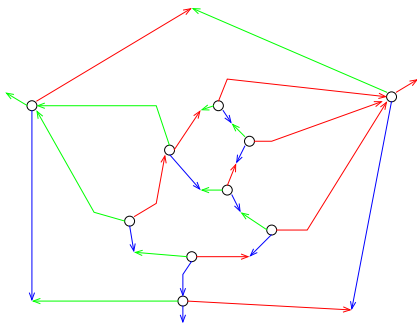

Dual rules

Generalization to (internally) 3-connected planar map

Felsner (2001), Miller (2002)

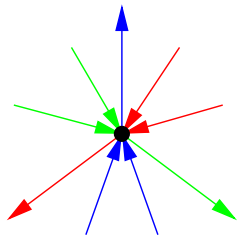

For every vertex

AND

No monochromatic cycles

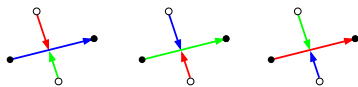
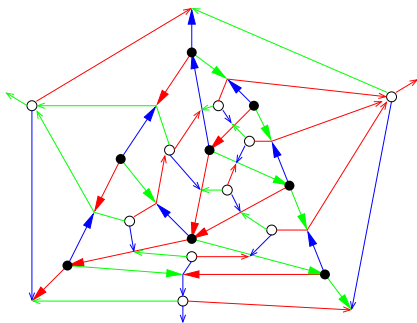

Dual rules

Generalization to (internally) 3-connected planar map

Gonçalves, Lévêque, Pinlou (2010)

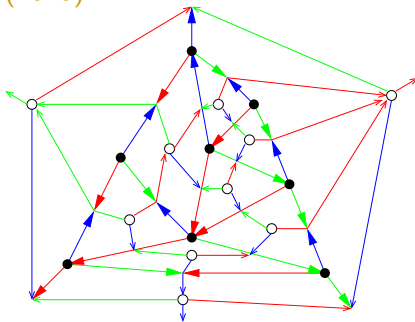
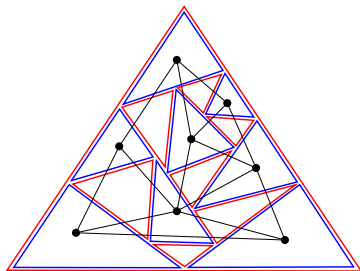

Generalization to (internally) 3-connected planar map

Gonçalves, Lévêque, Pinlou (2010)

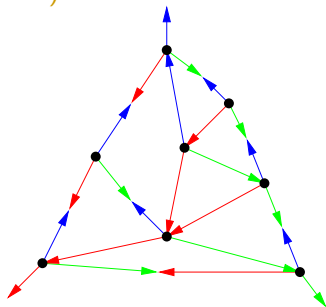
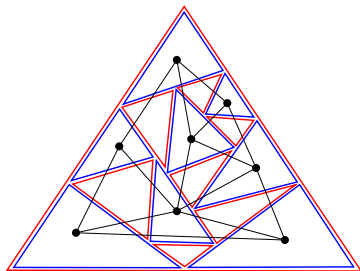

Generalization to (internally) 3-connected planar map

Gonçalves, Lévêque, Pinlou (2010)

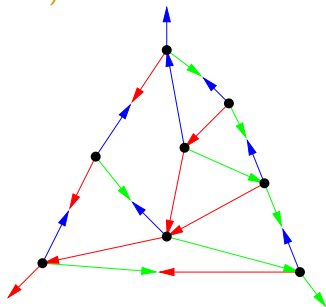
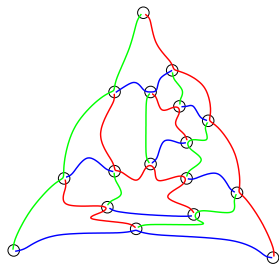

Generalization to (internally) 3-connected planar map

Gonçalves, Lévêque, Pinlou (2010)

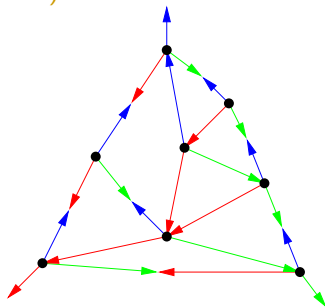
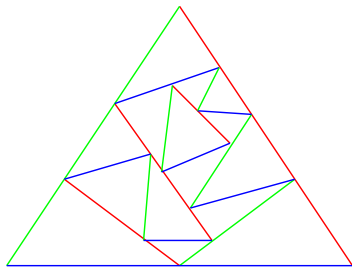

Generalization to (internally) 3-connected planar map

Gonçalves, Lévêque, Pinlou (2010)

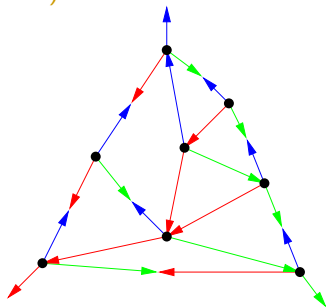
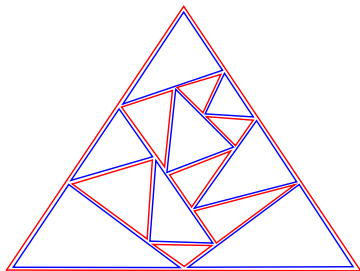

Generalization to (internally) 3-connected planar map

Gonçalves, Lévêque, Pinlou (2010)

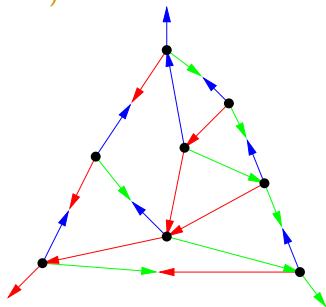
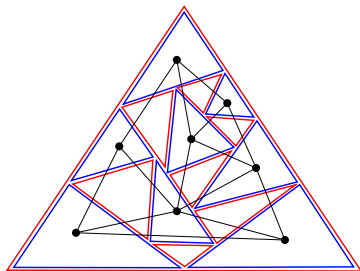

Orthogonal surfaces

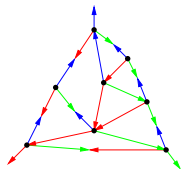
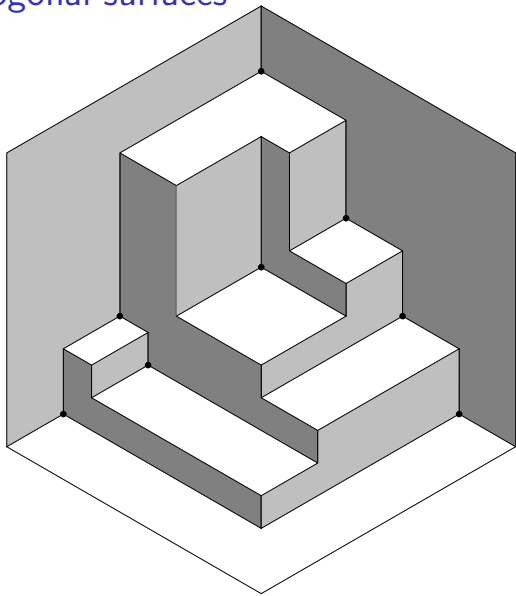

Orthogonal surfaces

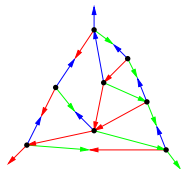
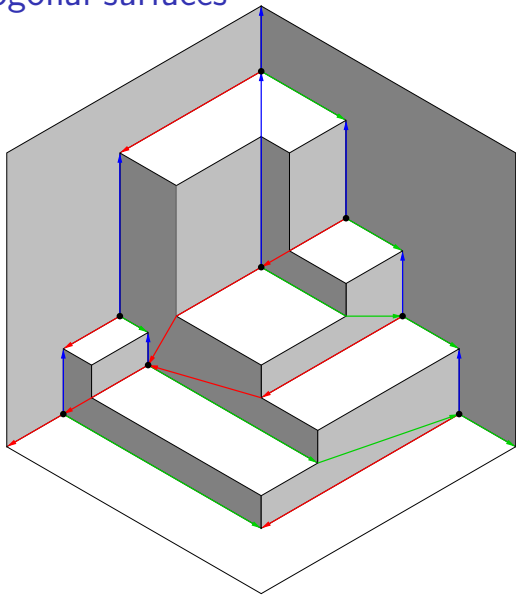

Orthogonal surfaces

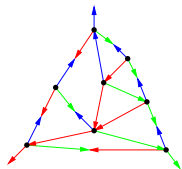
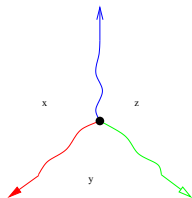
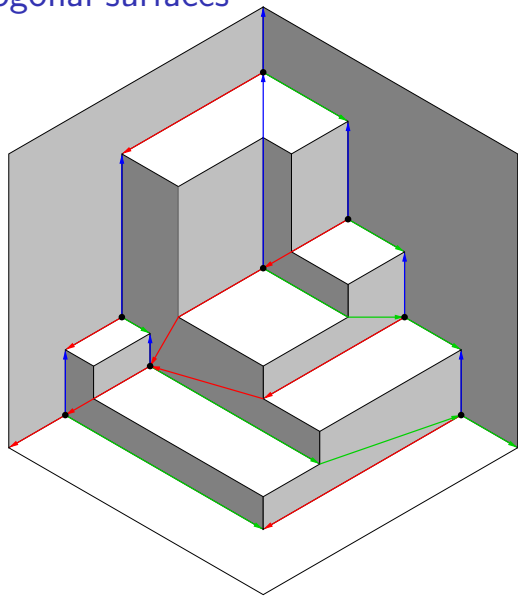

Orthogonal surfaces

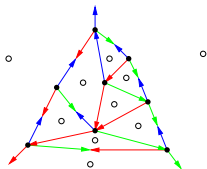
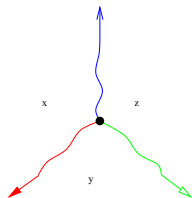
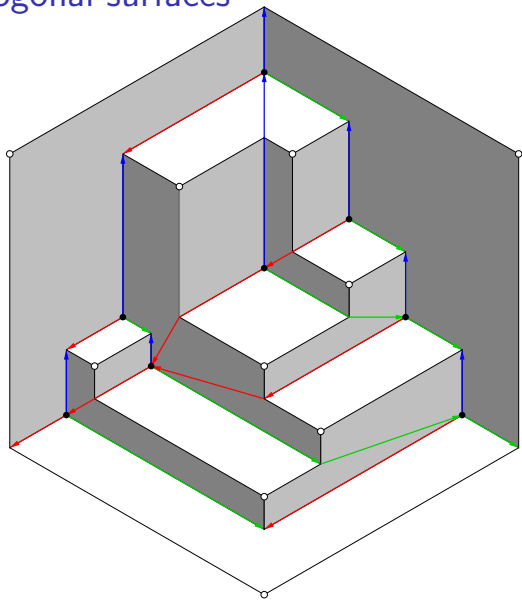

Orthogonal surfaces

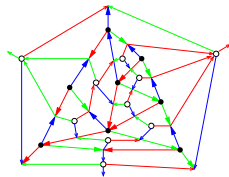
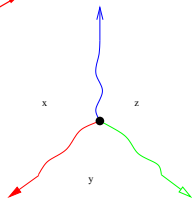
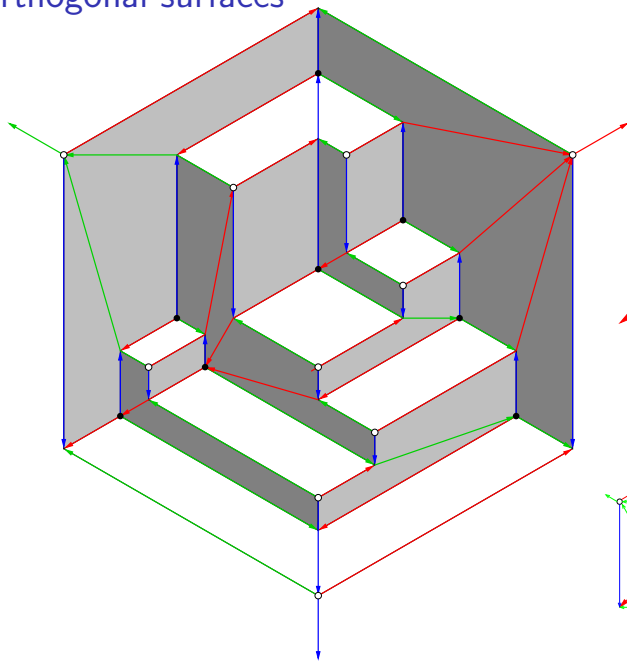

Orthogonal surfaces

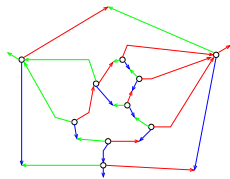
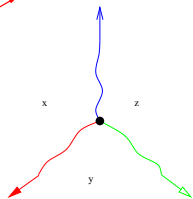
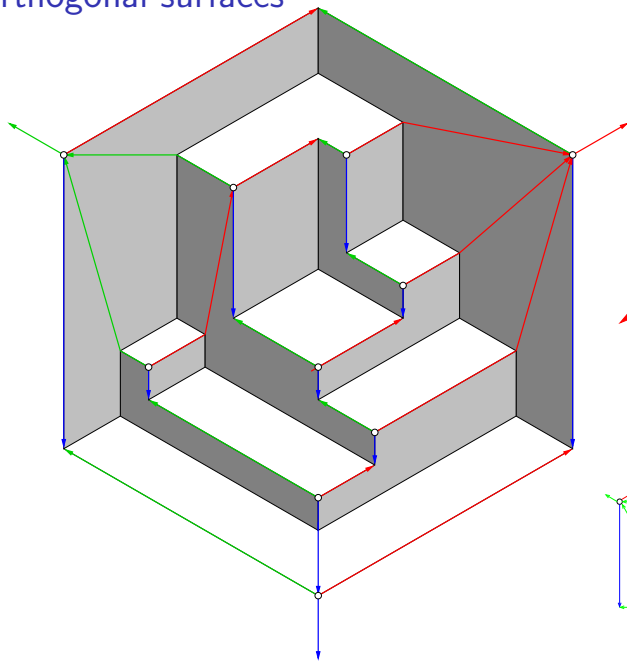

Orthogonal surfaces

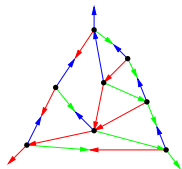
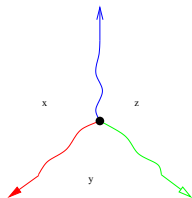
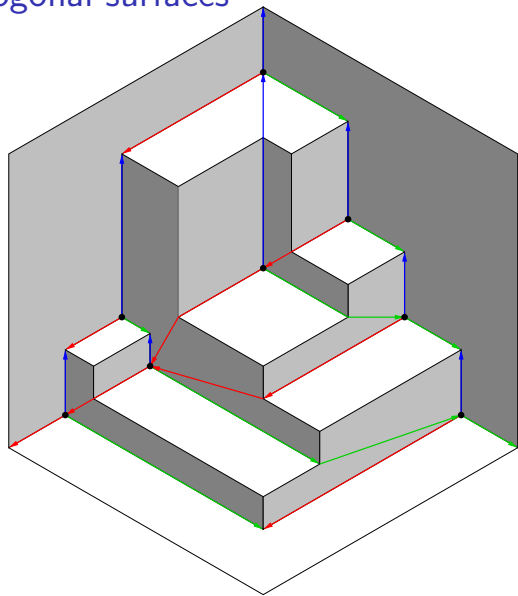

Orthogonal surfaces

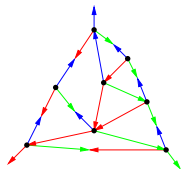
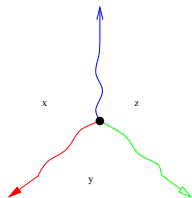
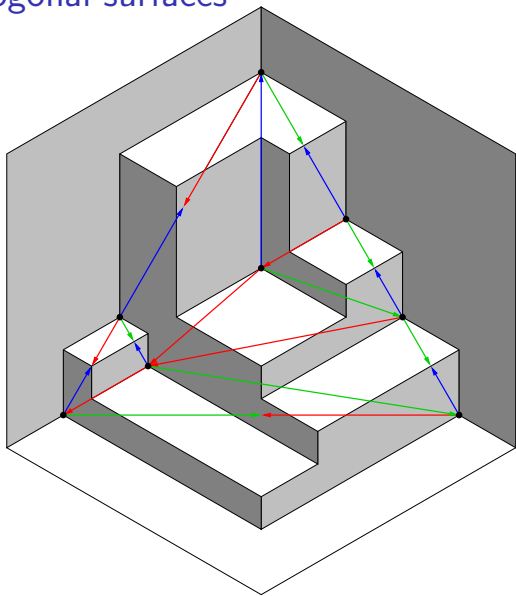

Orthogonal surfaces

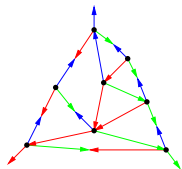
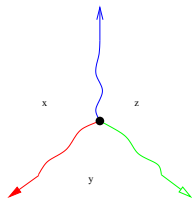
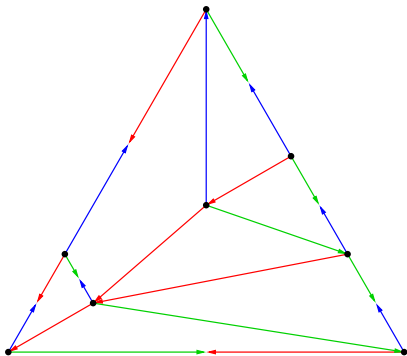

The torus

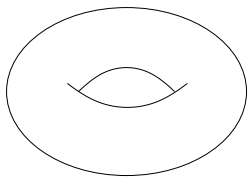

The torus

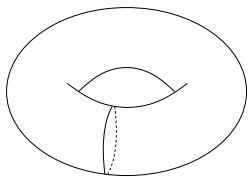

The torus

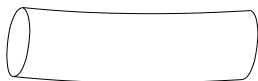
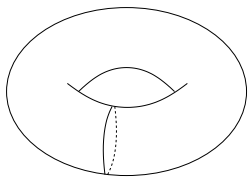

The torus

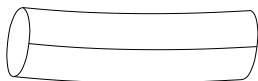
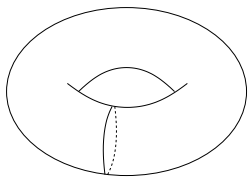

The torus

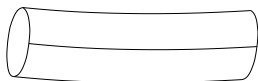
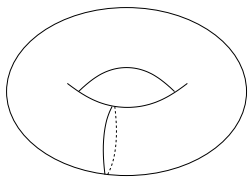

The torus

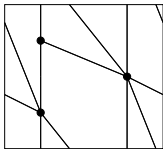
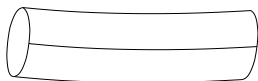
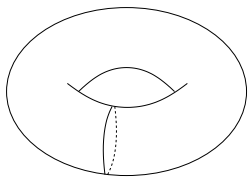

The torus

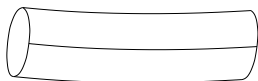
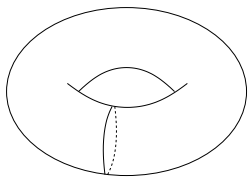

No loop and no multiple edges

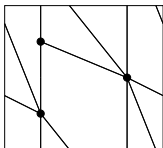

The torus

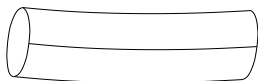
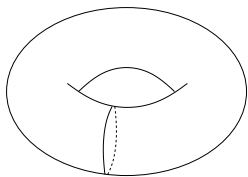

No **contractible** loop and no multiple edges

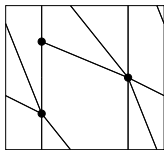

The torus

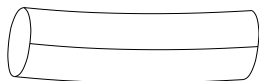
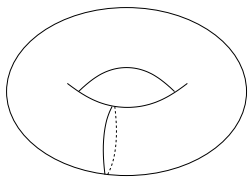

No **contractible** loop and no **homotopic** multiple edges

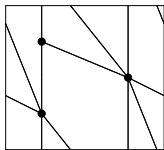

The torus

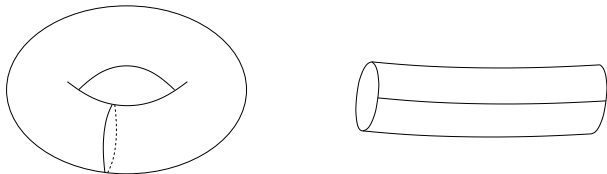

No **contractible** loop and no **homotopic** multiple edges

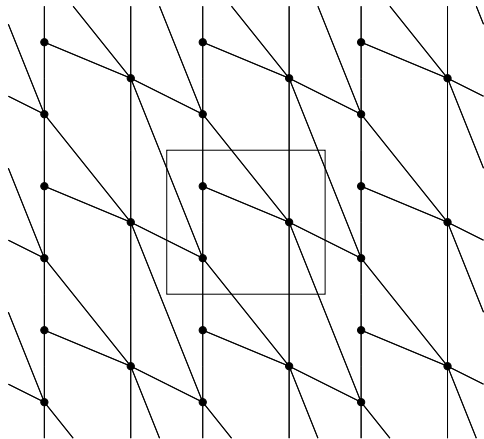

A generalization of Schnyder woods to higher genus

A generalization of Schnyder woods to higher genus

Castelli Aleardi, Fusy, Lewiner (2009) : applications to encoding

i) a small set \mathcal{E}^s of *special* edges,
doubly oriented and colored

(u, v, w)

at most $2 \cdot 2g$ multiple vertices
(incident to special edges)



$\mathcal{E}^s = \{e_1, e_2\}$

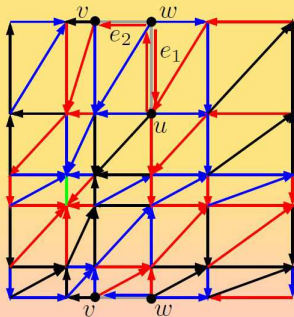

ii) a new local condition for
edges in a sector incident to
a multiple vertex

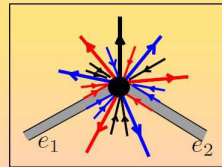

A different approach for the torus

A different approach for the torus

	Plane	Torus
Euler's Formula	$n - m + f = 2$	$n - m + f = 0$

A different approach for the torus

	Plane	Torus
Euler's Formula	$n - m + f = 2$	$n - m + f = 0$
Triangulation	$m = 3n - 6$	

A different approach for the torus

	Plane	Torus
Euler's Formula	$n - m + f = 2$	$n - m + f = 0$
Triangulation	$m = 3n - 6$	

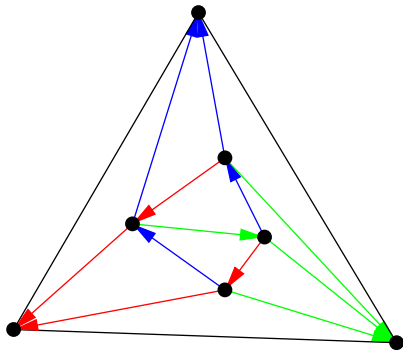

A different approach for the torus

	Plane	Torus
Euler's Formula	$n - m + f = 2$	$n - m + f = 0$
Triangulation	$m = 3n - 6$	$m = 3n$

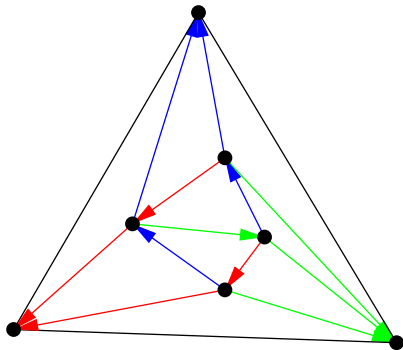

A different approach for the torus

	Plane	Torus
Euler's Formula	$n - m + f = 2$	$n - m + f = 0$
Triangulation	$m = 3n - 6$	$m = 3n$

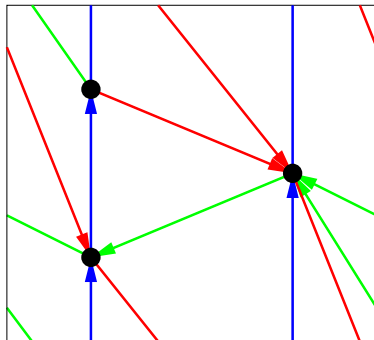

Definition of (generalized) Schnyder wood on the Torus

Definition of (generalized) Schnyder wood on the Torus

Planar Schnyder wood Felsner (2001)

- ▶ Schnyder property + half edge.
- ▶ No monochromatic cycle.

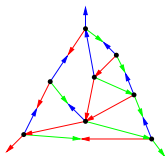

Definition of (generalized) Schnyder wood on the Torus

Planar Schnyder wood Felsner (2001)

- ▶ Schnyder property + half edge.
- ▶ No monochromatic cycle.

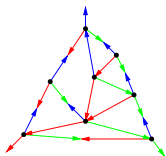

Toroidal Schnyder wood Gonçalves, Lévêque (2011)

Definition of (generalized) Schnyder wood on the Torus

Planar Schnyder wood Felsner (2001)

- ▶ Schnyder property + half edge.
- ▶ No monochromatic cycle.

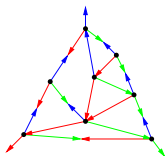

Toroidal Schnyder wood Gonçalves, Lévêque (2011)

- ▶ Schnyder property.

Definition of (generalized) Schnyder wood on the Torus

Planar Schnyder wood Felsner (2001)

- ▶ Schnyder property + half edge.
- ▶ No monochromatic cycle.

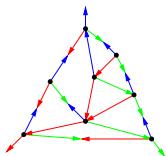

Toroidal Schnyder wood Gonçalves, Lévêque (2011)

- ▶ Schnyder property.
- ▶ No contractible monochromatic cycles ?

Definition of (generalized) Schnyder wood on the Torus

Planar Schnyder wood Felsner (2001)

- ▶ Schnyder property + half edge.
- ▶ No monochromatic cycle.

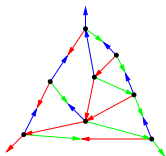

Toroidal Schnyder wood Gonçalves, Lévêque (2011)

- ▶ Schnyder property.
- ▶ No contractible monochromatic cycles ?

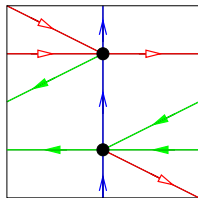

Definition of (generalized) Schnyder wood on the Torus

Planar Schnyder wood Felsner (2001)

- ▶ Schnyder property + half edge.
- ▶ No monochromatic cycle.

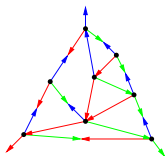

Toroidal Schnyder wood Gonçalves, Lévêque (2011)

- ▶ Schnyder property.
- ▶ No contractible monochromatic cycles ?

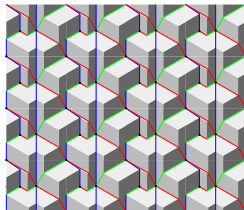
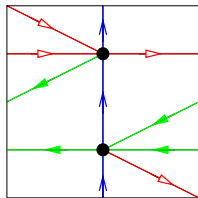

Definition of (generalized) Schnyder wood on the Torus

Planar Schnyder wood Felsner (2001)

- ▶ Schnyder property + half edge.
- ▶ No monochromatic cycle.

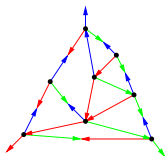

Toroidal Schnyder wood Gonçalves, Lévêque (2011)

- ▶ Schnyder property.
- ▶ **No contractible monochromatic cycles**

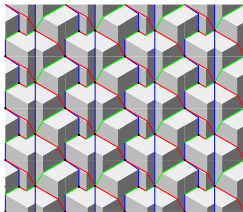
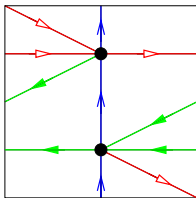

Definition of (generalized) Schnyder wood on the Torus

Planar Schnyder wood Felsner (2001)

- ▶ Schnyder property + half edge.
- ▶ No monochromatic cycle.

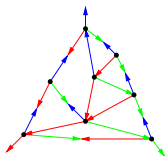

Toroidal Schnyder wood Gonçalves, Lévêque (2011)

- ▶ Schnyder property.
- ▶ **No contractible monochromatic cycles**
- ▶ Every monochromatic cycle intersects at least one monochromatic cycle of each color.

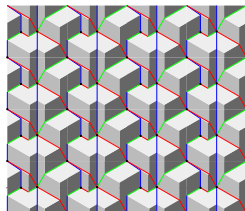
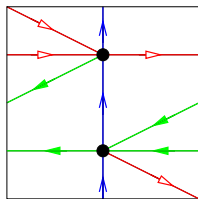

Definition of (generalized) Schnyder wood on the Torus

Planar Schnyder wood Felsner (2001)

- ▶ Schnyder property + half edge.
- ▶ No monochromatic cycle.

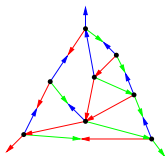

Toroidal Schnyder wood Gonçalves, Lévêque (2011)

- ▶ Schnyder property.
- ▶ Every monochromatic cycle intersects at least one monochromatic cycle of each color.

Definition of (generalized) Schnyder wood on the Torus

Planar Schnyder wood Felsner (2001)

- ▶ Schnyder property + half edge.
- ▶ No monochromatic cycle.

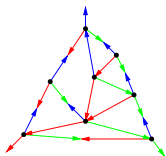

Toroidal Schnyder wood Gonçalves, Lévêque (2011)

- ▶ Schnyder property.
- ▶ Every monochromatic cycle intersects at least one monochromatic cycle of each color.

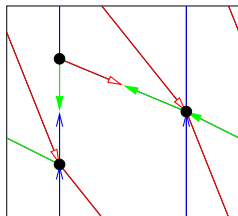

Definition of (generalized) Schnyder wood on the Torus

Planar Schnyder wood Felsner (2001)

- ▶ Schnyder property + half edge.
- ▶ No monochromatic cycle.

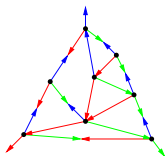

Toroidal Schnyder wood Gonçalves, Lévêque (2011)

- ▶ Schnyder property.
- ▶ Every monochromatic cycle intersects at least one monochromatic cycle of each color.

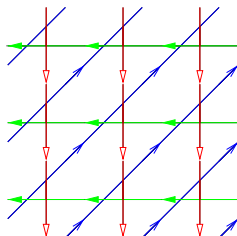
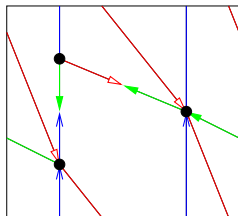

Definition of (generalized) Schnyder wood on the Torus

Planar Schnyder wood Felsner (2001)

- ▶ Schnyder property + half edge.
- ▶ No monochromatic cycle.

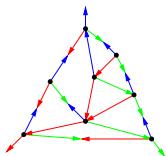

Toroidal Schnyder wood Gonçalves, Lévêque (2011)

- ▶ Schnyder property.
- ▶ Every monochromatic cycle intersects at least one monochromatic cycle of each color.

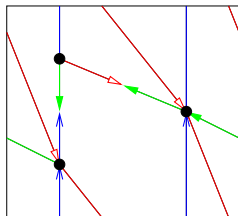

Definition of (generalized) Schnyder wood on the Torus

Planar Schnyder wood Felsner (2001)

- ▶ Schnyder property + half edge.
- ▶ No monochromatic cycle.

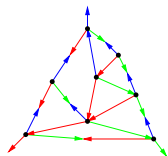

Toroidal Schnyder wood Gonçalves, Lévêque (2011)

- ▶ Schnyder property.
- ▶ Every monochromatic cycle intersects at least one monochromatic cycle of each color.

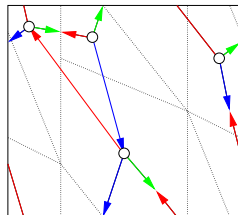
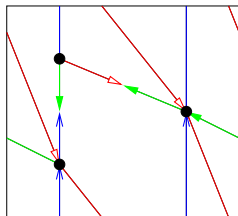

Definition of (generalized) Schnyder wood on the Torus

Planar Schnyder wood Felsner (2001)

- ▶ Schnyder property + half edge.
- ▶ No monochromatic cycle.

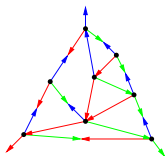

Toroidal Schnyder wood Gonçalves, Lévêque (2011)

- ▶ Schnyder property.
- ▶ Every monochromatic cycle intersects at least one monochromatic cycle of each color.

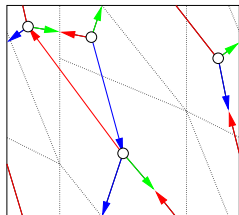
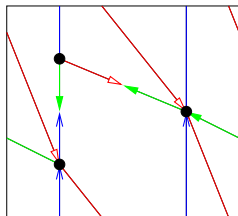

Theorem A toroidal map admits a Schnyder wood if and only if it is essentially 3-connected.

Definition of (generalized) Schnyder wood on the Torus

Planar Schnyder wood Felsner (2001)

- ▶ Schnyder property + half edge.
- ▶ No monochromatic cycle.

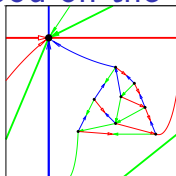

Toroidal Schnyder wood Gonçalves, Lévêque (2011)

- ▶ Schnyder property.
- ▶ Every monochromatic cycle intersects at least one monochromatic cycle of each color.

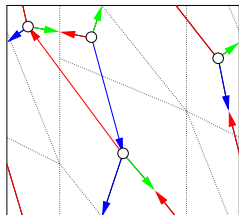
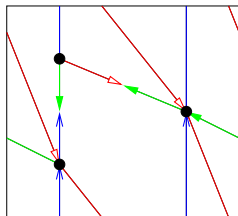

Theorem A toroidal map admits a Schnyder wood if and only if it is essentially 3-connected.

Orthogonal surfaces

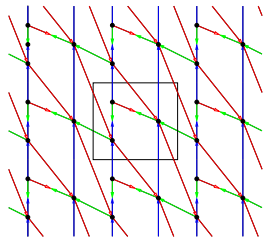
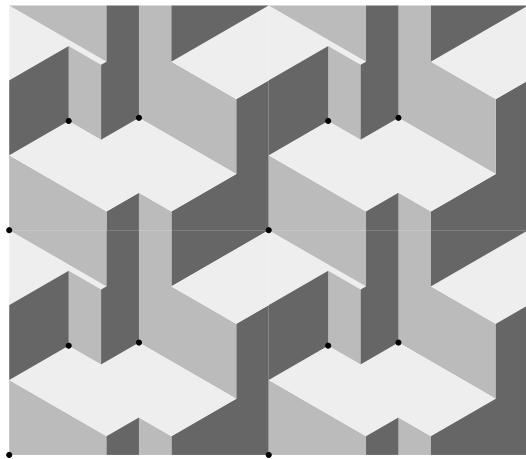

Orthogonal surfaces

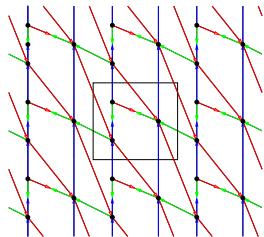
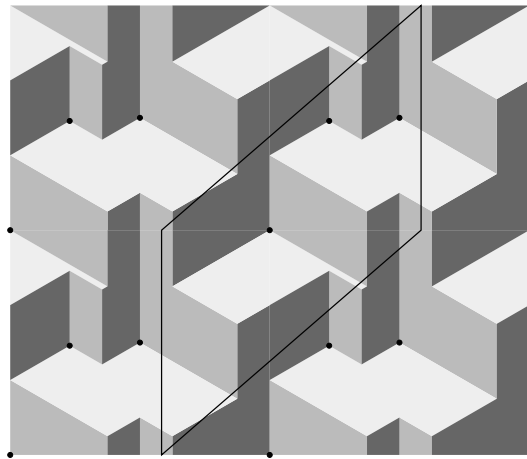

Orthogonal surfaces

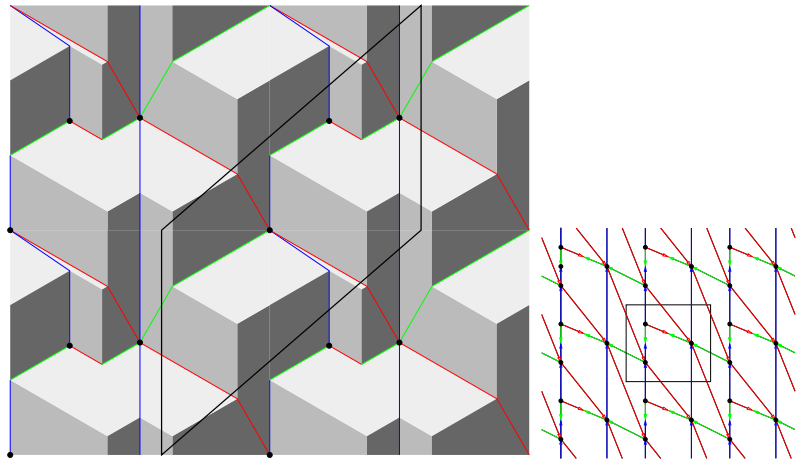

Orthogonal surfaces

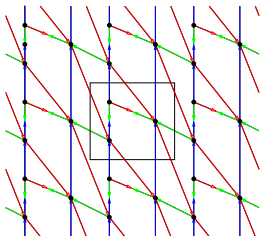
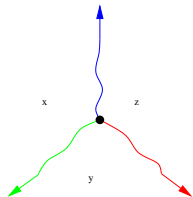
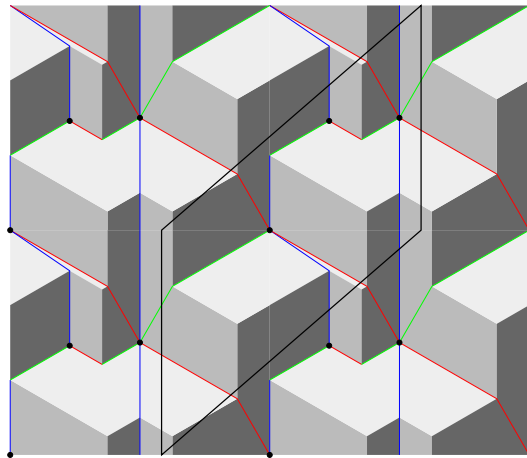

Orthogonal surfaces

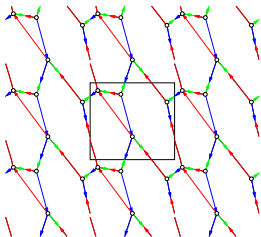
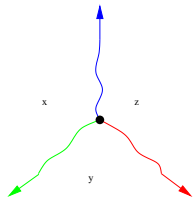
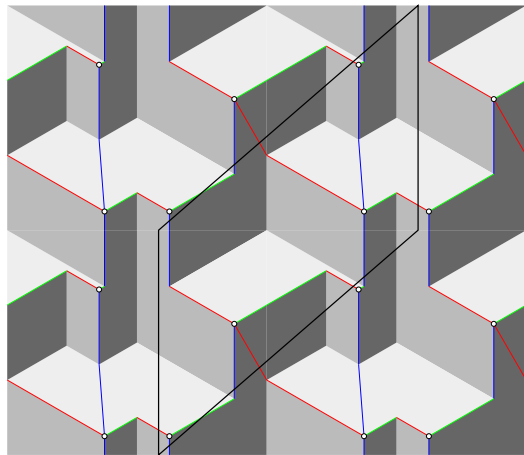

Orthogonal surfaces

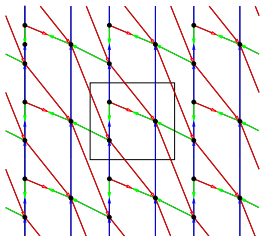
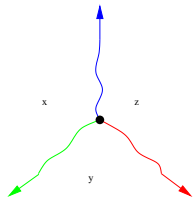
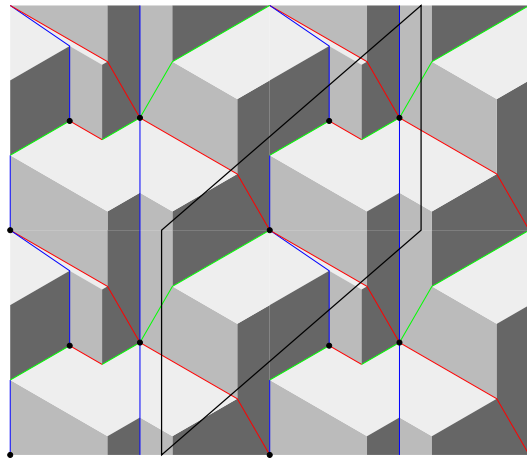

Orthogonal surfaces

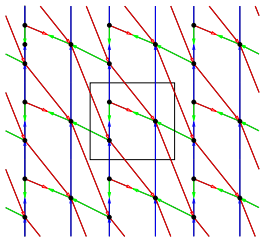
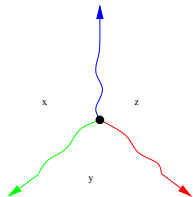
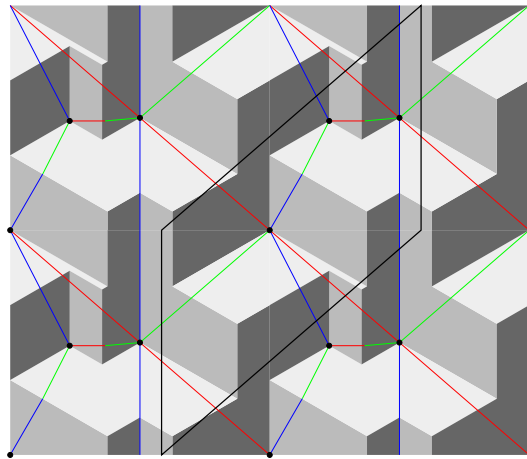

Orthogonal surfaces

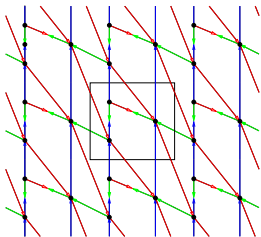
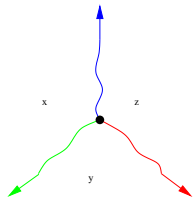
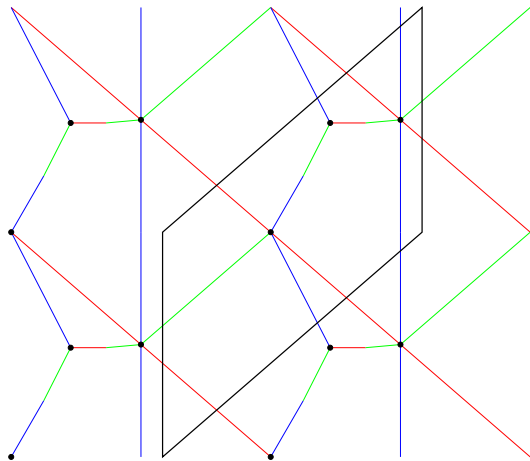

Orthogonal surfaces

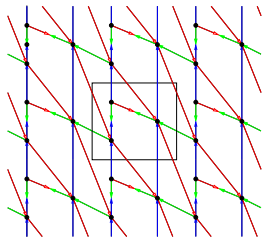
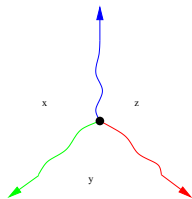
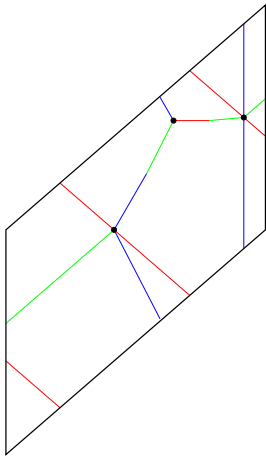

Orthogonal surfaces

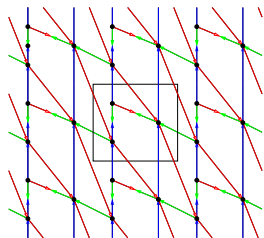
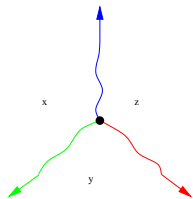
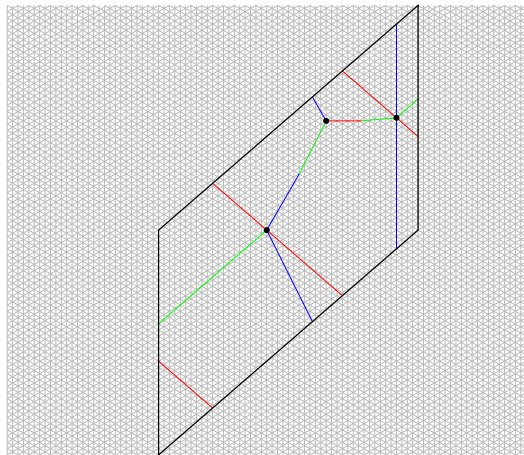

Orthogonal surfaces

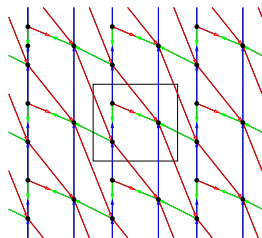
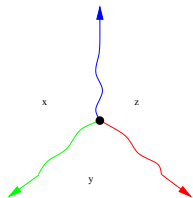
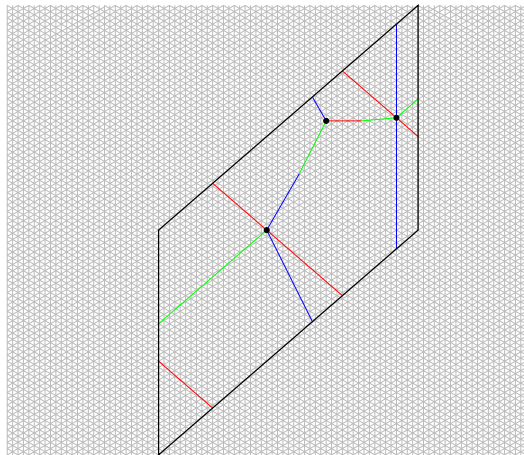

Theorem A simple toroidal map admits a straight line representation in a grid of size $\mathcal{O}(n^2) \times \mathcal{O}(n^2)$

Open questions

Open questions

- ▶ One component for each color ?

Open questions

- ▶ One component for each color ? \rightsquigarrow triangulations simples ?

Open questions

- ▶ One component for each color ? \rightsquigarrow triangulations simples ?
- ▶ Lattice structure ?

Open questions

- ▶ One component for each color ? \rightsquigarrow triangulations simples ?
- ▶ Lattice structure ? \rightsquigarrow bijection with 3-orientations

Open questions

- ▶ One component for each color ? \rightsquigarrow triangulations simples ?
- ▶ Lattice structure ? \rightsquigarrow bijection with 3-orientations
- ▶ Coplanar orthogonal surface ?

Open questions

- ▶ One component for each color ? \rightsquigarrow triangulations simples ?
- ▶ Lattice structure ? \rightsquigarrow bijection with 3-orientations
- ▶ Coplanar orthogonal surface ? \rightsquigarrow convex drawings for e3c

Open questions

- ▶ One component for each color ? \rightsquigarrow triangulations simples ?
- ▶ Lattice structure ? \rightsquigarrow bijection with 3-orientations
- ▶ Coplanar orthogonal surface ? \rightsquigarrow convex drawings for e3c
- ▶ Rigid orthogonal surface ?

Open questions

- ▶ One component for each color ? \rightsquigarrow triangulations simples ?
- ▶ Lattice structure ? \rightsquigarrow bijection with 3-orientations
- ▶ Coplanar orthogonal surface ? \rightsquigarrow convex drawings for $e3c$
- ▶ Rigid orthogonal surface ? \rightsquigarrow DM-dimension with faces

Open questions

- ▶ One component for each color ? \rightsquigarrow triangulations simples ?
- ▶ Lattice structure ? \rightsquigarrow bijection with 3-orientations
- ▶ Coplanar orthogonal surface ? \rightsquigarrow convex drawings for $e3c$
- ▶ Rigid orthogonal surface ? \rightsquigarrow DM-dimension with faces
- ▶ Contact system of triangles ?

Open questions

- ▶ One component for each color ? \rightsquigarrow triangulations simples ?
- ▶ Lattice structure ? \rightsquigarrow bijection with 3-orientations
- ▶ Coplanar orthogonal surface ? \rightsquigarrow convex drawings for $e3c$
- ▶ Rigid orthogonal surface ? \rightsquigarrow DM-dimension with faces
- ▶ Contact system of triangles ? \rightsquigarrow stretching

Open questions

- ▶ One component for each color ? \rightsquigarrow triangulations simples ?
- ▶ Lattice structure ? \rightsquigarrow bijection with 3-orientations
- ▶ Coplanar orthogonal surface ? \rightsquigarrow convex drawings for e3c
- ▶ Rigid orthogonal surface ? \rightsquigarrow DM-dimension with faces
- ▶ Contact system of triangles ? \rightsquigarrow stretching
- ▶ Enumeration, Compression, Spanners, . . .

Open questions

- ▶ One component for each color ? \rightsquigarrow triangulations simples ?
- ▶ Lattice structure ? \rightsquigarrow bijection with 3-orientations
- ▶ Coplanar orthogonal surface ? \rightsquigarrow convex drawings for e3c
- ▶ Rigid orthogonal surface ? \rightsquigarrow DM-dimension with faces
- ▶ Contact system of triangles ? \rightsquigarrow stretching
- ▶ Enumeration, Compression, Spanners, . . .
- ▶ Transversal structures, 2-orientations, . . .

Open questions

- ▶ One component for each color ? \rightsquigarrow triangulations simples ?
- ▶ Lattice structure ? \rightsquigarrow bijection with 3-orientations
- ▶ Coplanar orthogonal surface ? \rightsquigarrow convex drawings for e3c
- ▶ Rigid orthogonal surface ? \rightsquigarrow DM-dimension with faces
- ▶ Contact system of triangles ? \rightsquigarrow stretching
- ▶ Enumeration, Compression, Spanners, . . .
- ▶ Transversal structures, 2-orientations, . . .
- ▶ Higher genus, Higher dimension